

## USAGE FOR CESSPIT EMTIERS&WATER JETTING TRUCKS

### GENERAL DEFINITIONS



- 27485 LBS-FT Vertical Split Shaft PTO which is Designed with Clutch Mechanism and it Provides Hot Shift Feature.
- PTO Output is Capable To Transmit Up To 168 HP Max. At 3500 RPM
- The Hot Shift Featured Gearbox Can Be Installed As Horizontal If Needed.
- UARA.3005 Can Provide 100% Of Input Speed.
- PTO Output Can Be At Differential Side Or Cabin Side.
- Second PTO Output is An Option.
- In Case Of Double PTO Output is Requested, PTO Outputs Can Be Shifted Independently.
- PTO Outputs Can Be Design With All ISO Standard Flanges As Well As Suitable Housing For Any Kind Of Hydraulic Pump.
- Cooling System Can Be Mount On The Gearbox.
- Engage/Disengage Sensor & RPM Counter is An Option.
- Even Though It is Generally Used For Sewage Cleaning Trucks, It Can Be Used Any Application Which Needs Hot Shift Feature.



## USAGE FOR CESSPIT EMTIERS&WATER JETTING TRUCKS

### TECHNICAL INFORMATION

TECHNICAL VALUES			
	MAX. VALUES	INTERNAL RATIO	MAX. RPM
① & ②	27485 LB-FT	1/1	
③	268 HP	1/1.1 1/1.5	2500 RPM-3500 RPM
④	241 HP	1/1,25	2500 RPM-3500 RPM

WEIGHT	705 lbs
BODY MATERIAL	GH190
OIL TYPE QUANTITY	ATF 320 406 oz

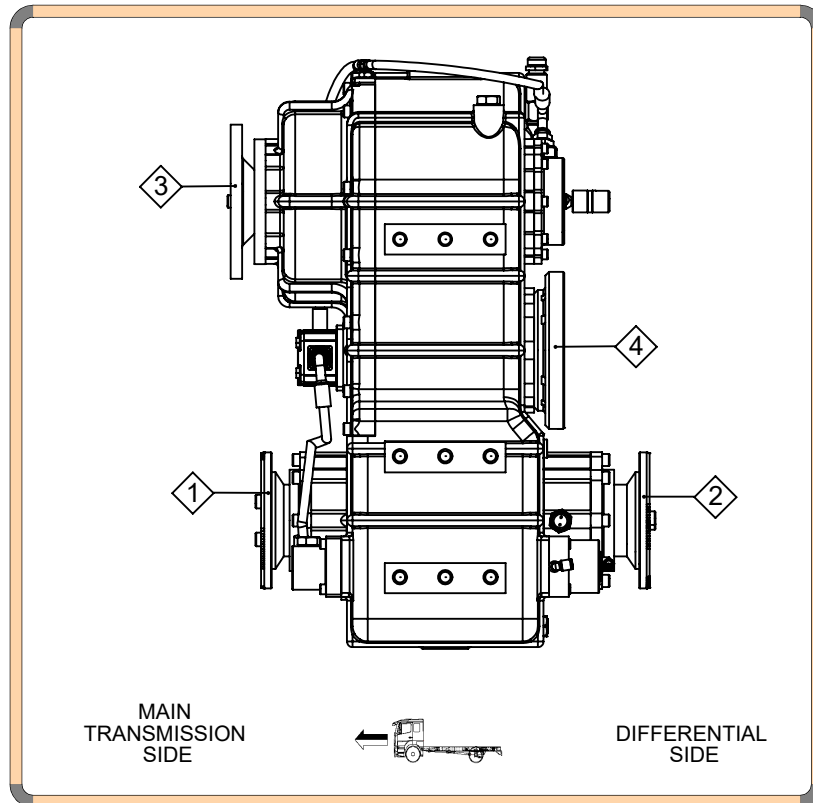

- Kozmaksan has all rights to change information in this catalogue without announcing it. This document is representing general information. It is not a contract.
- All information belongs to only PTO/Split Shaft. Do not use PTO/Split Shaft, if it is not suitable for your engine and main transmission.
- Pumps, shafts and other parts should not be longer or heavier than approved distance and weight by the manufacturer of main transmission and engine.

Please Contact with KOZMAKSAN, If You Have Any Question or Concern

Adress : 06370 TURKEY

Phone: +903122673971

E- Mail: [export@kozmaksan.com.tr](mailto:export@kozmaksan.com.tr)

Website: [www.kozmaksan.net](http://www.kozmaksan.net)

## USAGE FOR CESSPIT EMTIERS&WATER JETTING TRUCKS

### OPTIONS

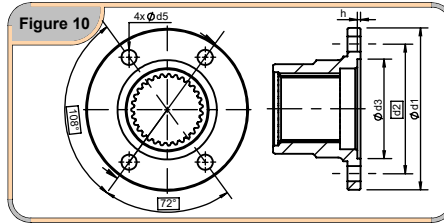
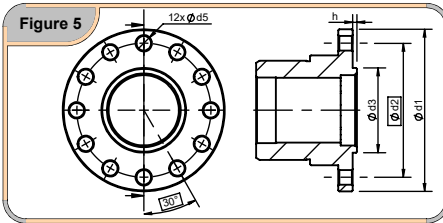
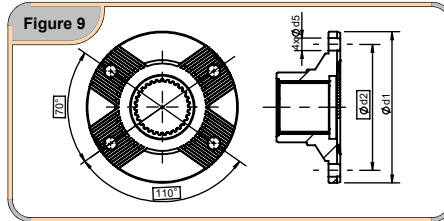
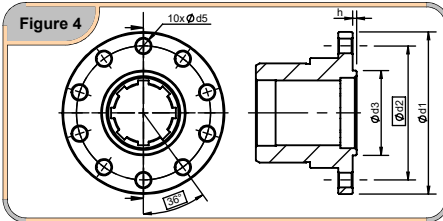
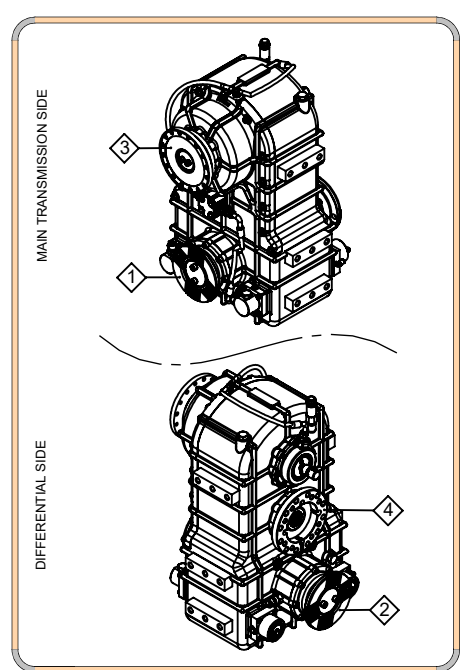
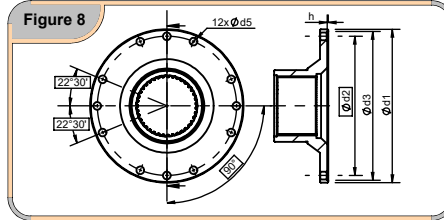
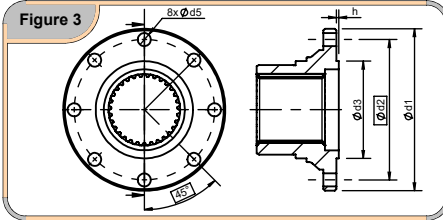
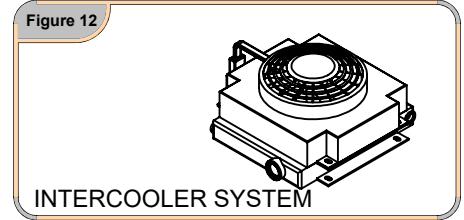
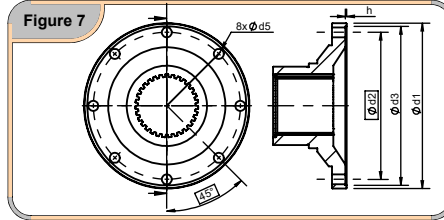
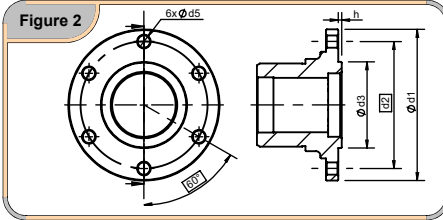
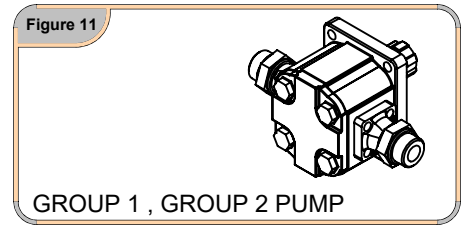
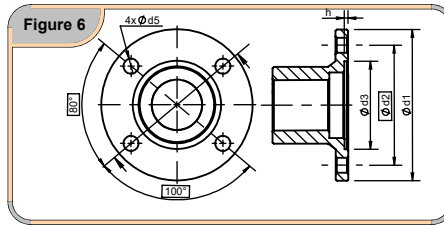
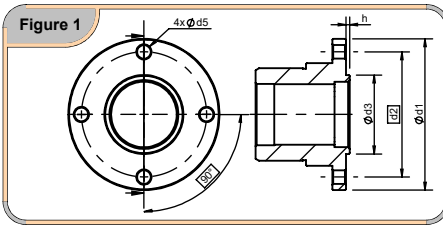

Figure No	No of Bolt	Ø d1	Ø d2	Ø d3	Ø d5	h	Standard	1	2	3	4	5	6	7	8	
2	6	3,93"	3,30"	2,24"	0,31"	0,09"										
3	8	4,72"	4"	2,95"	0,39"	0,09"	ISO 7646 - DIN 120				C06-145					
3	8	5,90"	5,11"	3,54"	0,47"	0,09"										
-	-	-	-	-	-	-										
6	4	3,81"	3,12"	2,37"	0,39"	0,09"										
6	4	4,56"	3,75"	2,75"	0,47"	0,09"										
6	4	5,74"	4,75"	3,75"	0,47"	0,09"										
7	8	6,88"	6,12"	6,62"	0,39"	0,05"	ISO 7647-SAE1600	C06-086	C06-086							
7	8	8"	7,25"	7,75"	0,39"	0,05"	ISO 7647-SAE1700				C06-125					
8	12	8"	7,25"	7,75"	0,39"	0,05"	ISO 7647-SAE1800	C06-158	C06-158							
-	-	-	-	-	-	-										
9	4"	4,72"	-	0,47"	0,43"	-										
9	4"	5,90"	-	0,51"	0,51"	-	ISO 8667 - T 150	C06-038	C06-038	C06-157						
9	4"	7,08"	-	0,59"	0,59"	-	ISO 8667 - T 180	C06-036	C06-036							

Please Contact with KOZMAKSAN, If You Have Any Question or Concern

Adress : 06370 TURKEY

Phone: +903122673971

E- Mail: [export@kozmaksan.com.tr](mailto:export@kozmaksan.com.tr)

Website: [www.kozmaksan.net](http://www.kozmaksan.net)

